

**PORODO**  
LIFESTYLE



**Porodo Lifestyle**  
**Portable Citrus Juicer**  
SKU: PD-LSSJ55-WH

# Table of Contents

Overview	2
Safety Instructions	2
Product Components	3
Food Contact Material	4
Instructions for Use	4
Specifications	5
Operation Steps	6
Cleaning Instructions	6
Disposal	7
Troubleshooting	7
Material Contents	8
Warranty	9
Contact Us	9

## Overview

The Porodo lifestyle portable citrus juicer allows you to effortlessly extract fresh and healthy juice from oranges, ensuring you can enjoy refreshing juice every day. With its innovative design and compact build, it maximizes space while delivering optimal juicing results. Before using the product, please carefully read this User Manual to guarantee correct usage and keep it secure for future reference.

## Safety Instructions

- 1.** This product operates using a DC motor powered by a lithium battery. Use a standard USB charger for charging. A full charge requires 3.5 hours.
- 2.** Before the first use, ensure all parts in contact with food are cleaned and dried.
- 3.** The head component should only be removed after the product has been switched off and the product's moving parts has come to a complete stop.
- 4.** When cleaning the product, ensure the power switch is turned off. Do not wash the motor unit with water to prevent water from entering and damaging the electronics.
- 5.** Avoid operating the juicer for more than 10 consecutive cycles to prevent excessive strain on the motor and electronic components, which may reduce the product's lifespan.
- 6.** The juicer is equipped with an overload protection feature. If excessive pressure or food blockage occurs, the unit will stop and the red indicator light will flash for 5 seconds. After clearing the obstruction, the juicer can be restarted.
- 7.** Do not attempt to sterilize any part of the juicer with hot water or place it in a microwave oven at temperatures above 60°C, as this may lead to deformation or damage.
- 8.** Do not place the main components of the juicer in the dishwasher or any cleaning equipment, and ensure that no water enters the motor compartment.
- 9.** Do not use abrasive cleaners or harsh chemicals to clean the product.

10. Only use oranges for juicing to avoid damage to the machine.
12. Avoid dropping the appliance from any height or subjecting it to strong impacts. Such actions could damage the motor or other components.
13. Follow the capacity limits outlined in the user manual to prevent material overflow, which may damage the juicer.
14. If the appliance is not in use, always disconnect the power supply before disassembling, cleaning, or replacing any parts. Keep out of reach of children.
15. Turn off the power and disconnect the appliance before replacing accessories or contacting moving parts.
16. This product is equipped with a built-in lithium battery. Do not expose it to high temperatures, and never discard the product in general waste.
17. Before discarding the appliance, remove the battery. Use appropriate tools to safely remove the battery and dispose of it in a separate battery waste bin.
18. The appliance must be powered off before removing the battery.
19. Dispose of the battery in accordance with local regulations for hazardous waste.
20. This product is intended for home use only. Improper use, professional applications, or failure to follow the instructions in this manual can result in serious injury or damage and will void the warranty.

## Product Components

1. Host
2. Drinking cup
3. Silicone plug
4. Pressing head
5. Juicing cone
6. Juicing cup

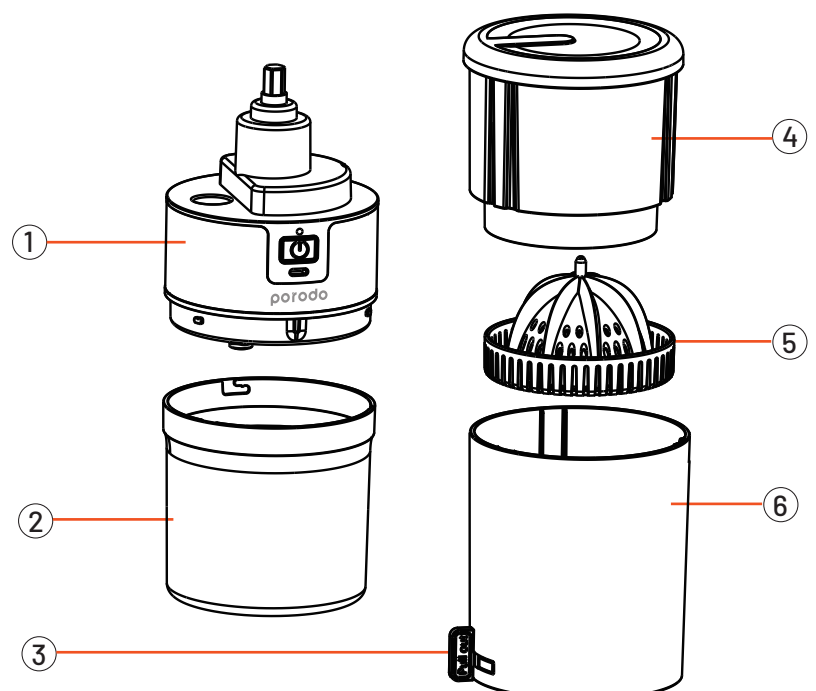

## Food Contact Material

This product is designed for safe contact with food. Please follow the instructions for proper use. The materials and components that come into contact with food meet the requirements of GB 4806.1-2016 and the corresponding national food safety standards. The details are as follows:

Material	Components	Standard
AS	Juicing cup/Drinking cup	GB 4806.7-2016
PP	Shell/Bottom cap/Pressing head	GB 4806.7-2016
ABS	Juicing cone	GB 4806.7-2016
Silicone Rubber	Silicone plug	GB 4806.7-2016

## Instructions for Use

1. Review the previous instructions before proceeding.
2. Prepare the ingredients by washing and cutting them into halves. Larger ingredients should be cut into smaller pieces to fit the juicer.
3. Assemble the juicer: Attach the drinking cup to the host, then place the juicing cone onto the host. Afterward, place the fruit (with the pulp side facing the juicing cone) into the juicing cone and secure the pressing head into the juicing cup.
4. Start the juicing process: Double-click to turn on the device, and the juicing cone will begin to rotate. Apply appropriate pressure to the pressing head to extract the juice (the initial startup will take about 1 minute).

**Note:** Ensure the amount of juice extracted does not exceed the maximum fill line of the cup to prevent spillage.

5. After the juicing process is complete, the product will automatically enter standby mode. The silicone stopper will be activated, and the juice will flow into the drinking cup, ready for you to enjoy.

6. **Charging:** If the device cannot be started and the indicator light flashes red, connect the USB cable to the charging port, compatible with various 5V power supplies. When fully charged, the indicator light will turn white.

**7.** The product can be charged using any compatible smartphone charger via the USB cable or a power bank. It will fully charge in approximately 4 hours and can be used for up to 25 cycles (1 minute per cycle).

## Specifications

Power	45W
Battery Capacity	1300mAh*2 (2600mAh)
Input	5V/1A
Battery Voltage	7.4V
Recharge Time	3.5 Hours
Juicing Cup	160mL
Drinking Cup	500mL
Net Weight	666g
Product Size	105 x 260mm

### Pay Attention to Environmental Protection

- 1.** After powering off the appliance, use a tool to carefully pry or break the shell.
- 2.** Remove the battery from the appliance and dispose of it in a designated waste bin for professional recycling.

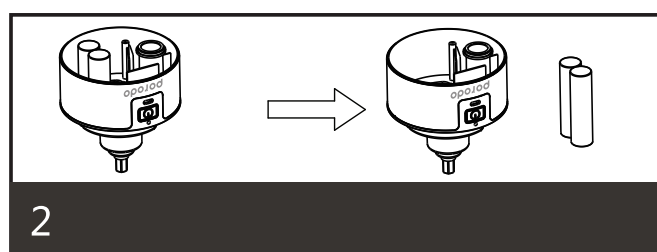
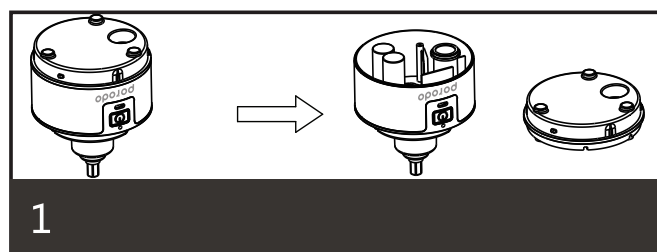

## Operation Steps

1. Loading the Cup: Attach the drinking cup securely to the base unit.
2. Loading the Juicing Cone: Place the juicing cone onto the host.
3. Add Ingredients: Prepare and add the ingredients to the juicing cone.
4. Powering the Appliance: Press down to lock the unit, then double-click to start the operation.
5. Juicing Process: The juice will begin running into the glass.
6. Drinking Directly: Once the juicing is complete, drink the fresh juice directly.
7. Low Battery: If the indicator light flashes red, the appliance is low on power.
8. Fully Charged: When the light turns white and remains steady, the appliance is fully charged and ready for use.

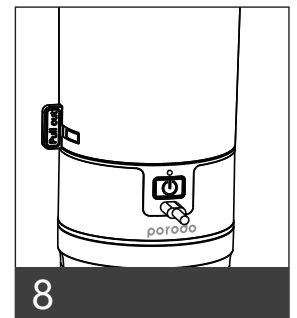
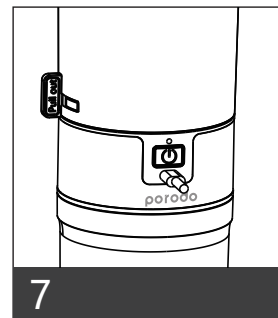
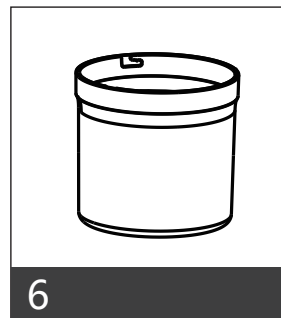
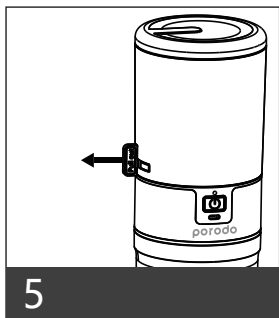
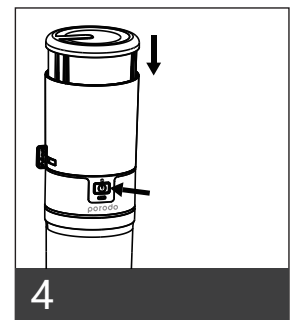
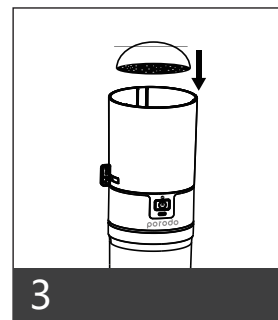
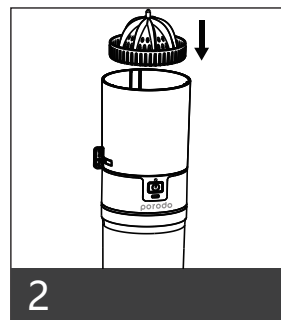
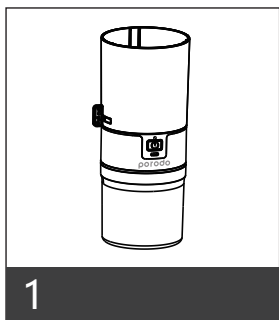

## Cleaning Instructions

1. Do not wash the motor or base unit under running water; instead, use a damp cloth to clean them.
2. The juicing cup, cone, and other detachable parts can be washed with water but should not be exposed to direct water flow for extended periods.
3. After washing, make sure all parts are fully dried before reassembling the juicer to ensure optimal performance and longevity.

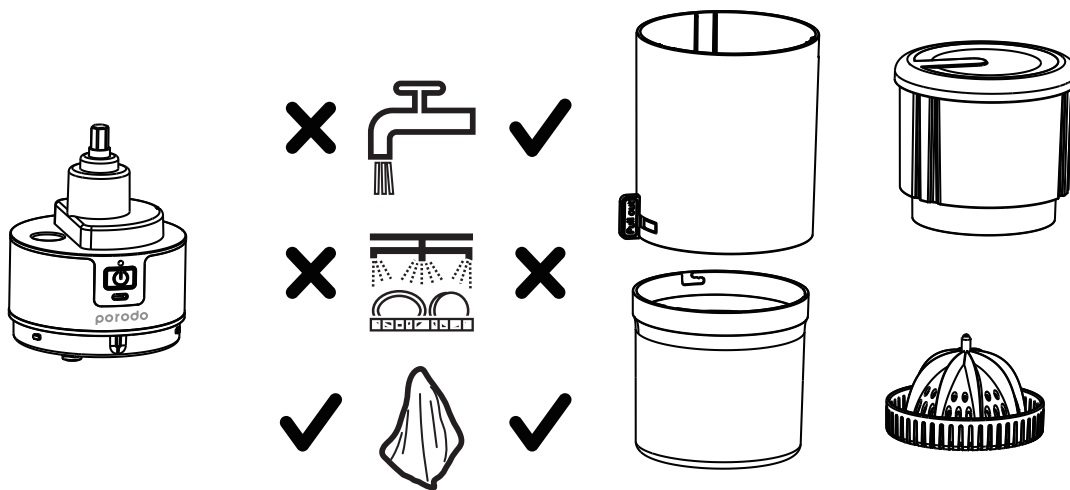

## Disposal



This product must not be disposed of as unsorted household waste. It is important to separate such waste for proper treatment and recycling, in compliance with local waste management regulations.

## Troubleshooting

**1. Problem:** Does not work and blinks red 5 times

Cause: Battery low

Solution: Please charge it in time.

**2. Problem:** Does not work and the red light is on for 5 seconds

Cause: Overload protection – Food too big or too hard, etc.

Solution: Cut fruit smaller or use softer ingredients.

**3. Problem:** Excessive noise

Cause: Accessories are not installed properly

Solution: Install the fittings correctly.

**4. Problem:** Juice spills during stirring

Cause: The juice exceeds the maximum water level or the waterproof stopper is not plugged tightly

Solution: The juice extracted should not exceed the highest water level, and the silicone stopper should be plugged tightly.

# Material Contents

To protect the environment, it is your responsibility as a consumer to separate this product or its parts from domestic waste once they are no longer in use. Please send it to a qualified recycling facility, where it will be safely disassembled, sorted, and reused according to national regulations.

Hazardous Substances in Products						
Part Name	Lead (Pb)	Mercury (Hg)	Cadmium (Cd)	Hexavalent Chromium (Cr(VI))	Polybrominated Biphenyls (PBB)	Polybrominated Diphenyl Ethers (PBDE)
Plastic parts	○	○	○	○	○	○
Hardware	○	○	○	○	○	○
Silica gel	○	○	○	○	○	○
Sticker labels	○	○	○	○	○	○
Screws	○	○	○	○	○	○
Circuit board	×	×	○	○	○	○
Motor components	×	○	○	○	○	○
<p>This table is prepared in accordance with SJ/T 11364</p> <p>O: The content of the hazardous substance in all materials of the component is below the limit requirements specified in GB/T 26572.</p> <p>X: The content of the hazardous substance in at least one material of the component exceeds the limit requirement of GB/T 26572.</p>						
<div style="display: flex; align-items: center;">  <p>This product is designed for an environmental protection life of 10 years. This lifespan is based on the company's design specifications and is valid under normal usage as detailed in the product manual.</p> </div>						

## Important Note:

Other components and homogeneous materials in this product, not listed in the table above, do not contain hazardous substances. All listed components and homogeneous materials comply with China RoHS regulations. Rest assured, the product meets the strict requirements regarding hazardous substances.

## **Warranty**

Products that you buy directly from our **Porodo** website or shop come with a 24-month warranty.

When you buy **Porodo** products from any of our approved sellers, you only get a 12-month warranty. If you want to extend this warranty, go to our website at **porodo.net/warranty** and fill out the form with your information. Don't forget to upload a picture of the product too. After we've checked and accepted your request, we'll send you an email to confirm that your product's warranty has been extended.

For more info, please check:  
**porodo.net/warranty**

## **Contact Us**

If you have any questions about this Privacy Policy, please contact us at:

**info@porodo.net**

Website: **porodo.net**

Service Support: **support@porodo.net**

Instagram: **porodo**