

porodo



**Porodo Soundtec
TWS Earphone AP4**
—with Touch Screen—
—SKU: PD-STGUIDE—

Before installing and using the product, please carefully read this User Manual to guarantee correct usage and keep it secure for future reference.

Package Contents

1. One earphone casing
2. One set of earphones
3. Silicon ear tips in three sizes: S / M / L
4. One charging cable
5. One user manual

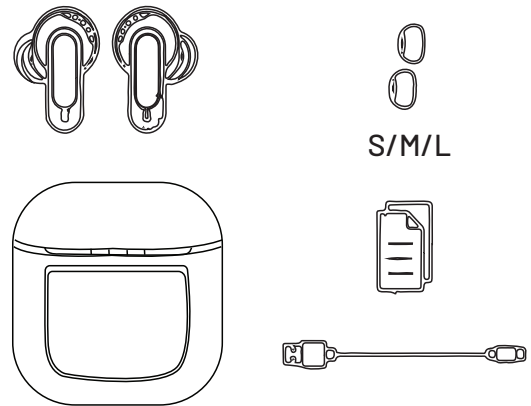

Before the First Use

The product requires to be charged prior to the initial use. Please adhere to the following instructions:

1. Prepare the charging cable and connect the casing to a power supply source. Activate the casing sensor by placing your finger over the casing button for 2 seconds. Insert the cable into the designated input port on the casing to commence the charging sequence.
2. Remove both earphones from the charging case.
3. Place both earphones inside casing to initiate their charging.

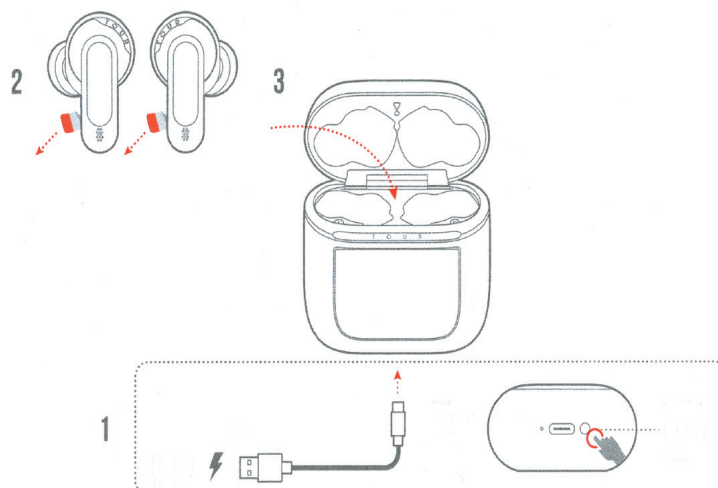

Wearing Method

Try different size earphone tips for optimal fit and audio performance.

1. The package includes three earphone tip sizes: small (**S**), medium (**M**), and large (**L**).

Attach the chosen tip on each earphone as instructed by the picture.

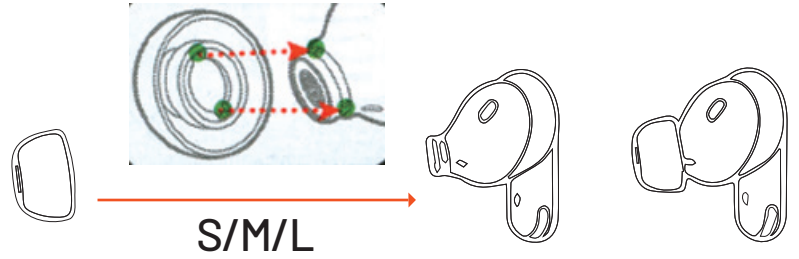

2. Remove the earphones from the charging case. Put each earphone in the ear and rotate to achieve the optimal fitting.

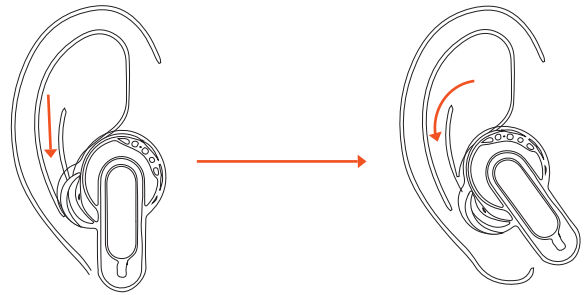

3. Connect the earphone to your smartphone.

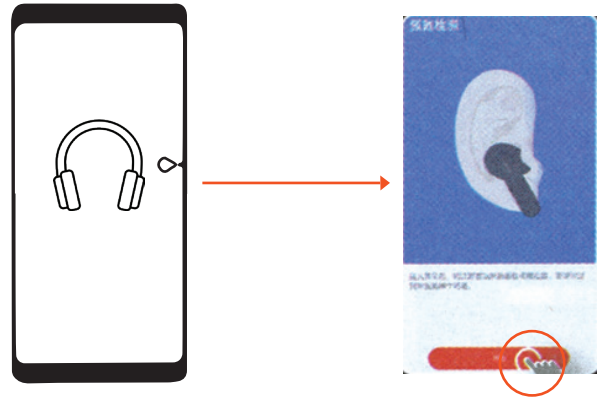

Operating Instructions

LED indicator status

- **Turn on the headset:** The red and blue lights flash alternately
- **Left/right interconnection:** The red and blue lights of the main ear flash quickly, and the secondary ear turns off
- **Connected to Bluetooth:** Light turns off
- **Headphone charging:** The red light of the headset is always on
- **Charging case:** Solid white light
- **The compartment is fully charged:** The white light turns off

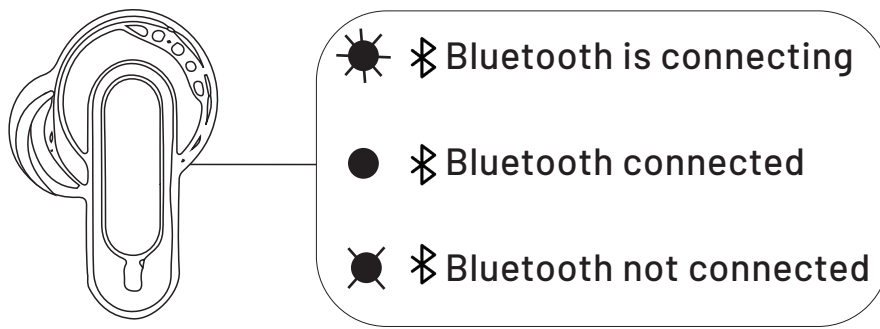

Function operation

- **Power on:** Open the charging compartment cover to automatically power on.
- **Power off:** Put the charging compartment cover and shut it down.
 1. The headset turns off after 3 minutes of no device connection in pairing mode.
 2. The distance between the headset and the connected device is too far, and there is no device connection. It will shut down after 3 minutes.
 3. If the battery voltage of the headset is lower than 3.1V, it will automatically shut down.
- **Connect to the mobile phone:** After the headset is turned on, open the Bluetooth of the mobile phone and search for the corresponding device name "**Soundtec Guide**"
- **Play/pause music:** Click the touch key on either earphone
- **Previous song:** Music playback status Double-click the left earphone touch key
- **Next song:** Music playback status Double-click the right earphone touch key
- **Volume up:** Triple-click the left ear touch key during music
- **Volume down:** During music, triple-click the right ear button.
- **Answer a call:** When a call comes in, click the touch key on any side of the headset to answer the call.
- **Hang up the call:** During a call, double-click on any side of the headset and touch the key to hang up the call.
- **Reject a call:** When a call comes in, press and hold either earphone for

2-1 seconds to reject the call.

- **Start Siri:** Press and hold the touch button on either earphone for 5-3 seconds
- **Transparency/noise reduction/normal mode switching:** press and hold any ear touch button for 5 seconds to switch (can be switched in cycles)
- **Clear pairing records:** When the headset is turned on and not connected, click the touch button 5 times (deletes left/right ear and Bluetooth records)

Place the earphones in the casing and close the lid to switch off and safely store the earphones.

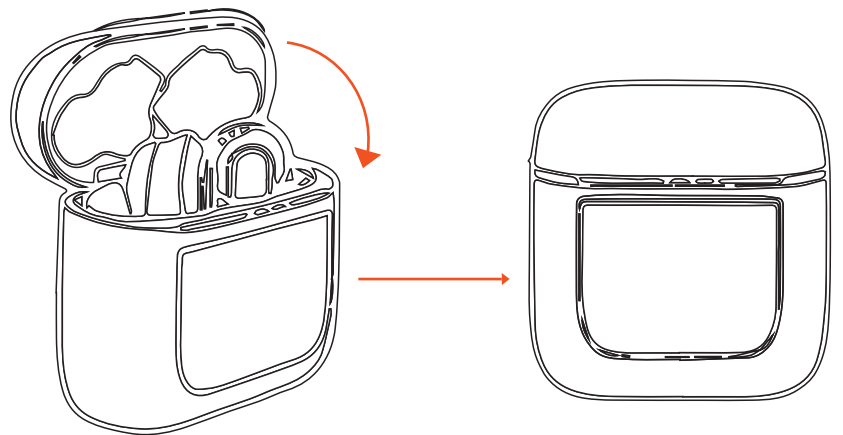

Prompt sound

- **Power ON:** "deng deng deng" rising tone
- **Power OFF:** "deng deng deng" flat tone
- **Connect to Bluetooth:** "bang" piano sound
- **Disconnect Bluetooth:** "du du"
- **Maximum volume:** "du"
- **Mode switching:** transparency/ANC on/ANC off
- **Clear records:** "deng deng deng"

Bluetooth Connection

1. Open the casing and take the earphones out.
2. Turn on Bluetooth on your smart device.
 - 2.1 For smartphones: Enable Bluetooth connection. Search for device name "Soundtec Guide" from the list of available devices. Select the product to pair and establish a connection.
 - 2.2 For laptops with Windows 10, version 1803 or later: Enable Bluetooth connection. Utilize Microsoft Swift Pair and choose the device name "Soundtec Guide" to pair and connect

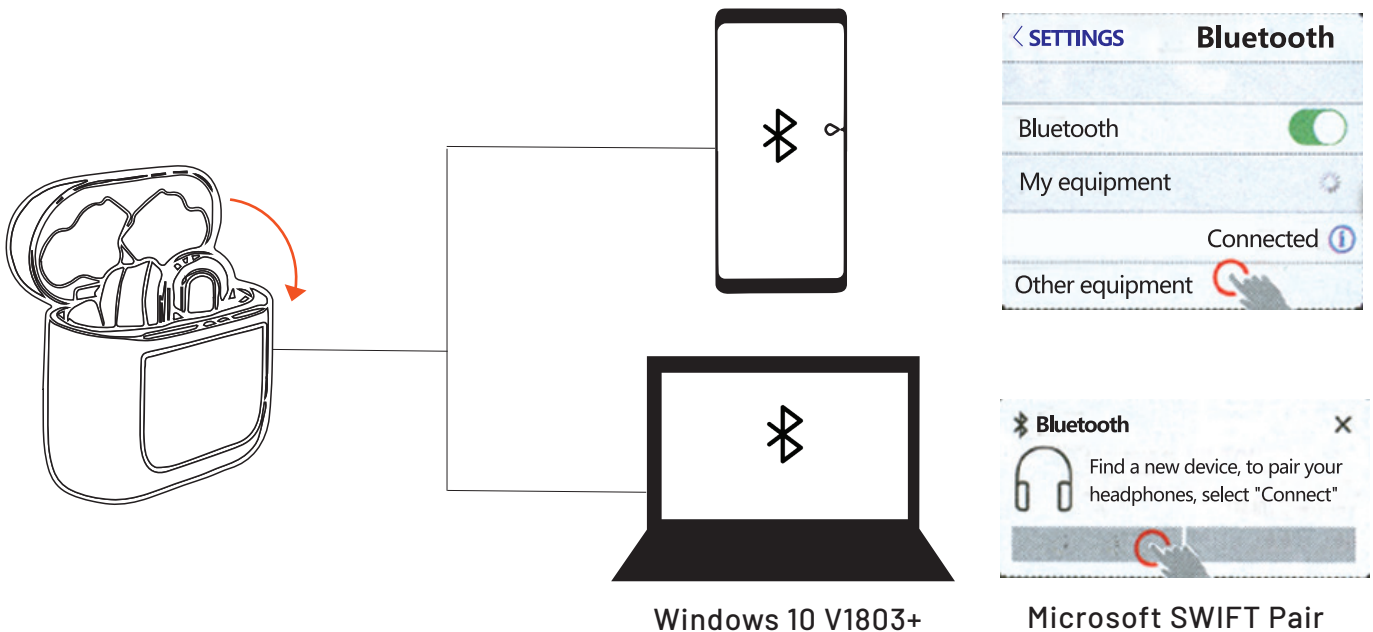

Dual Connection and Synchronization

Stereo Mode: Employ both earphones for a full stereo experience.

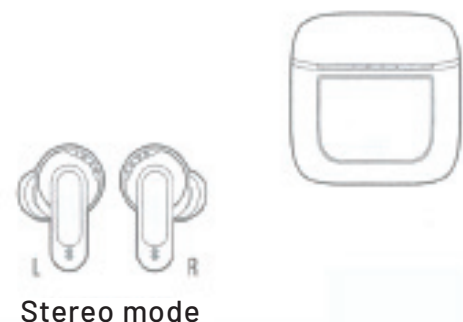

Mono Mode: Opt for either the left or the right earphone for single-ear listening.



Mono mode



Touch Command

1. Touch sensors on earphones

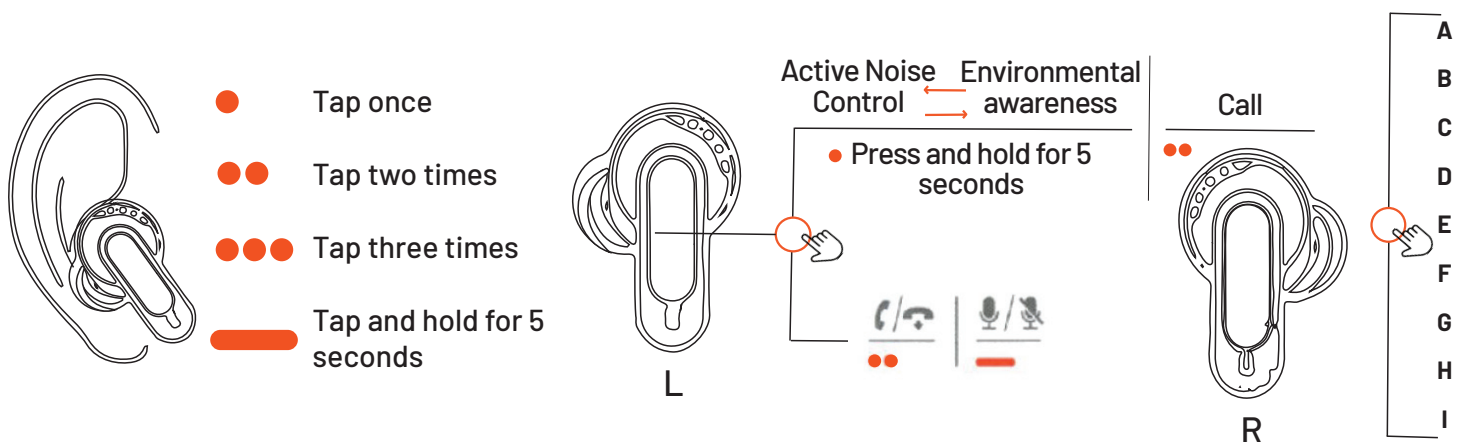

A: To Play/Pause: Single-tap the touch sensor.

B: To play the previous track: Double-tap the left earphone.

C: To play the next track: Double-tap the right earphone.

D: To increase volume: Triple-tap the right earphone.

E: To decrease volume: Triple-tap the left earphone.

F: To answer a call: Single-tap the left or right earphone.

G: To reject a call: Tap and hold the finger on the right or left earphone for 2 seconds.

H: To activate voice assistant: Tap and hold the finger on the right or left earphone for 2 seconds.

I: To enable Active noise reduction/Environmental awareness: Tap and hold the finger on the right or left earphone for 5 seconds.

2. Touch sensors on the casing

1. Tap the casing sensor to lock/unlock the casing

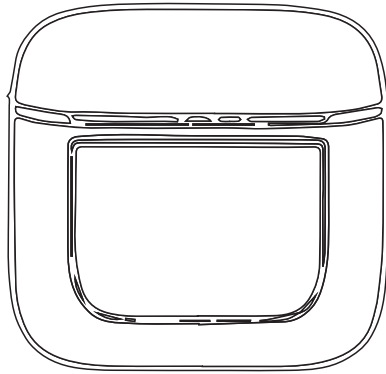

Tap once

2. Slide your finger across the screen to access various features



Slide your finger

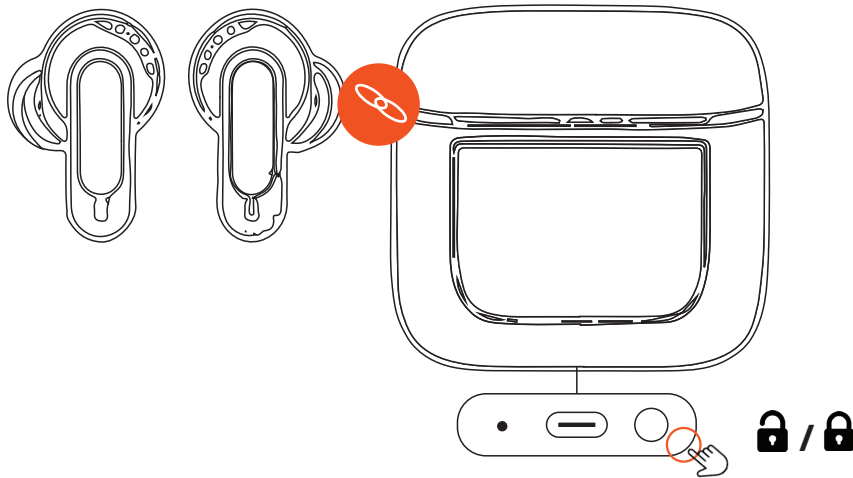

3. Touch Screen

To use the different functions, navigate the touch screen.

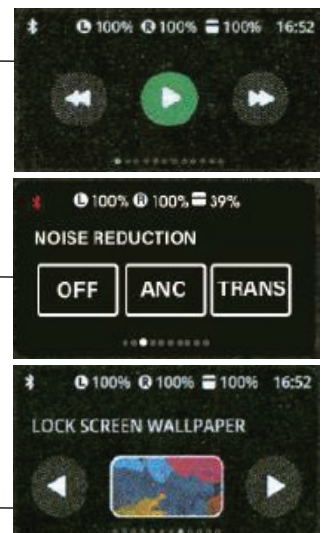
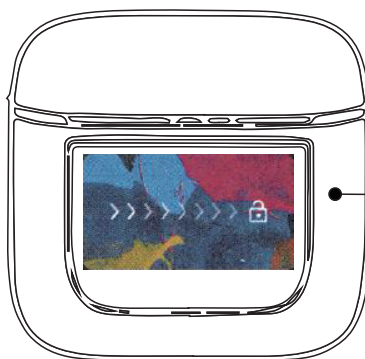

Silence Mode

Silence Mode ON:

Hold your fingers on earphones touch sensor for 5 seconds to activate 'silence mode'. In this case no Bluetooth connection is needed and 'Active noise reduction' feature is on. A fully charged earphone operates in sleep mode for 10 hours. This feature can be used when user wants to sleep.

Silence Mode OFF:

Press and hold the earphones' touch sensor for 5 seconds to exit 'silence mode' and return to the standard functionality. The 'Active noise reduction' remains active, and a Bluetooth connection is necessary to play audio.

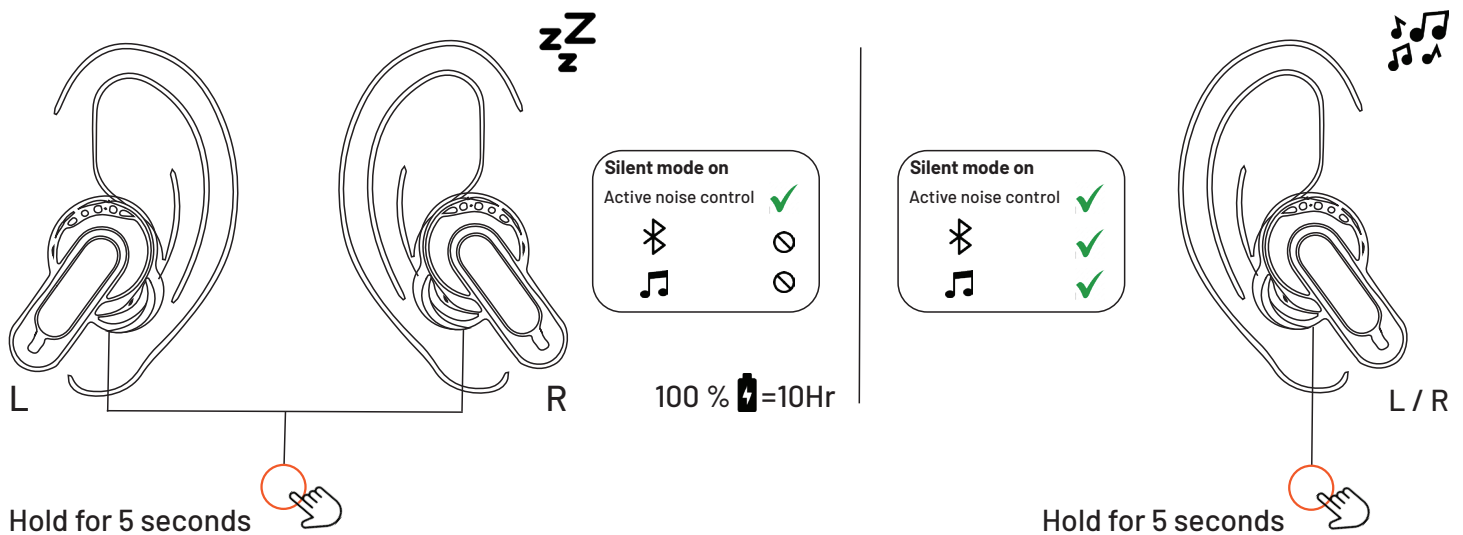

Charging

Connecting the casing to a power source initiates the charging of the casing, followed by the charging of the earphones when placed inside the casing.

Note:

To optimize battery longevity, it is recommended to perform a charging cycle at least once every three months. Note that battery performance will vary based on how the device is utilized and the settings configured.

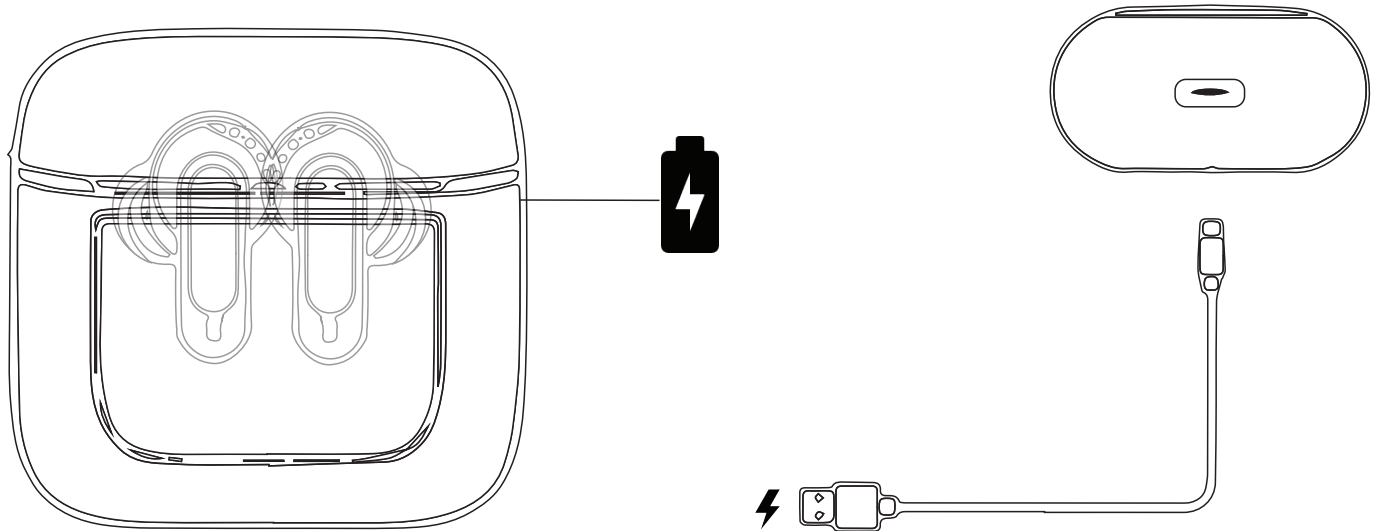

Precautions

1. Never use abrasive cleaners to clean this product.
2. Do not allow this product to be heated or near fire sources. Such as a cooking stove.
3. Do not expose this product to direct sunlight for a long time.
4. Never dispose of this product in fire. Avoid explosion.
5. Do not attempt to disassemble this product to make any modifications. Because it does not contain any repair components.
6. Never use this product in the rain.
7. If you do not plan to use this product for a long time, please store it in a dry environment and charge the earphones at least once a month to extend life and avoid extreme temperatures and dust.

Specifications

Model	Porodo Soundtec TWS Earphone AP4 with Touch Screen
SKU	PD-STGUIDE
Stereo Type	TWS (True Wireless Stereo)
Tracking System	Stereo
The control mode	Headphone: Touch control Casing: Color screen touch control
Bluetooth version	5.4
Bluetooth operating frequency	2.402GHz-2.480GHz
Bluetooth range	≤ 10 m
Speaker power	3 mW
Headphone RF power level	10 mW
Frequency response	30Hz~20KHz
Speaker type	Φ10mm@32Ω
Microphone MIC sensitivity	Silicon microphone -38dB±2dB
Speaking time	About 3 to 4 hours (%80 volume)
standby time	About 30 hours
Charging input	Type-C DC-5V / 1000mA
Charging time	Casing ≤2.5 hours / Earphones ~1.5 hours
Battery cycle life	Charge and discharge cycles ≥ 300 times
Temperature range	Working Temperature: -10~40°C Storage Temperature: -10~45°C
Humidity range	Working humidity: less than 70 % Storage humidity: less than 70 %
Storage conditions	The product should be kept in a dry and ventilated room to avoid contact with corrosive substances and away from fire and heat sources. The product should be charged once a month during storage.

Transportation

Initially, the manufactured products are packed into boxes for transportation when half-charged (50-90 % battery state). Please note that severe vibration, impact or extrusion should be prevented during transportation. The product must be protected from sun and rain.

Warranty

Products that you buy directly from our **Porodo** website or shop come with a 24-month warranty.

When you buy **Porodo** products from any of our approved sellers, you only get a 12-month warranty. If you want to extend this warranty, go to our website at <https://porodo.net/warranty> and fill out the form with your information. Don't forget to upload a picture of the product too. After we've checked and accepted your request, we'll send you an email to confirm that your product's warranty has been extended.

For more info, please check:

porodo.net/warranty

Contact Us

If you have any questions about this Privacy Policy, please contact us at:

info@porodo.net

Website: porodo.net

Service Support: support@porodo.net

Instagram: [porodo](https://www.instagram.com/porodo)